

## Safety Information Bulletin

### Airworthiness

**SIB No.: 2019-07R1**

**Issued: 25 February 2025**

**Subject: Sailplane Rigging – Procedures, Inspections and Training**

#### Revision:

This SIB revises EASA SIB 2019-07 dated 30 April 2019.

#### Ref. Publications:

- Luftfahrt-Bundesamt (LBA), Lufttüchtigkeitsanweisung (LTA) [1993-001/3](#) and LTA [1994-001/2](#) dated 09 April 1998.
- Air Accident Investigation Unit of Belgium Final Report [AAIU-2010-27](#) dated 07 January 2011.
- EASA [SIB 2011-11](#) dated 25 May 2011.
- EASA [SIB 2012-04](#) dated 15 March 2012.
- Air Accidents Investigation Branch of the United Kingdom (AAIB UK) Aircraft Accident Report [EW/C2010/08/02](#) dated 10 December 2014.
- Bundesstelle für Flugunfalluntersuchung (BFU) Investigation Report [BFU18-1190-3X](#) dated 15 April 2021.
- AAIB UK Aircraft Accident Report [EW/C2017/04/01](#) dated 08 March 2018.
- EASA [AD 2018-0081](#) dated 11 April 2018.
- Air Accident Investigation Unit - Ireland [Report No: 2021-011](#) dated 17 December 2019.
- AAIB UK, Aircraft Accident Report [AAIB-25958](#) dated 11 June 2020.
- EASA [AD 2020-0260](#) dated 26 November 2020.
- BFU Investigation Report [BFU22-0920-3X](#) dated 5 May 2024.
- Bureau d'enquêtes et d'analyses pour la sécurité de l'aviation civile (BEA) Final Report [BEA2022-0176](#) dated 30 August 2023.
- Transportation Safety Bureau of Hungary Closing Statement [2022-0930-4](#) dated 11 April 2023.
- Dutch Safety Board (DSB) *Take-off with unconnected ailerons, Glasflügel Standard Libelle 201 B, PH-1656* [Quarterly Aviation Report 2023-Q1](#) dated June 2023.
- AAIB UK, Aircraft Accident Report [AAIB-28680](#) dated 12 October 2023.
- British Gliding Association (BGA) Safety Briefing of the BGA "[Is Your Glider Fit for Flight?](#)", dated 28 January 2023.
- BGA Safety information "[A toolbox of safe rigging mitigations for use by clubs and individuals](#)" dated 17 March 2023.
- DSB *Loss of control, Eiriavion Oy PIK-20 D, PH-661* [Quarterly Aviation Report 2023-4](#) dated March 2024.

---

For information only. Recommendations are not mandatory



**Applicability:**

All sailplanes and powered sailplanes, subject to rigging.

**Description:**

Statistical data, accident reports, and occurrence reports indicate a number of incidents, which were caused by improper execution of rigging procedures and its subsequent inspection. The number of fatalities related to improper rigging is accumulating to 3 to 4 per year in Europe.

The nature of these incidents can be grouped as follows:

- Incorrectly installed and connected main wing.
- Incorrectly attached wingtips and winglets.
- Incorrectly connected horizontal stabilizer.
- Controls not connected or incorrectly connected.
- Not secured or incorrectly secured control connections.
- Not installed or installed incorrectly pressure probes, clogged or partially clogged static and total pressure ports.

Reasons for rigging errors can be grouped as follows:

- Insufficient awareness of the safety criticality for the correct execution of the rigging procedure.
- Insufficient sense of responsibility for carrying out rigging correctly.
- Uncoordinated teamwork with lack of communication during the rigging process; Failure to identify the person responsible.
- Rigging procedure was interrupted - the person executing the rigging was distracted or interrupted, and consequently omitted important steps.
- The rigging procedure was not correctly followed.
- The rigging procedure outlined in the sailplane manual was difficult to understand.
- The rigging procedure was not well known by the person executing the rigging.
- The mechanical principles of the connection and/or its securing were not understood by the person executing the rigging.
- Connections and/or securing were not, or incorrectly inspected.
- False positive results when conducting only a visual control check following rigging.
- Positive control checks not performed.

An inadequately connected wing, wing tips, winglets or horizontal stabilizer could lead to its separation from the wing or fuselage, potentially resulting in partial or full loss of control of the sailplane.

Since EASA SIB 2019-07 was issued, more accident investigation reports have been published, therefore this SIB revision includes them in the Reference Publications list.

In addition, the recommendation for 'a positive control check' has been even more strongly emphasised. This SIB also recommends operators to establish a procedure for the sign-off of the 'after rigging inspection'.



At this time, the safety concern described in this SIB is not considered to be an unsafe condition that would warrant Airworthiness Directive (AD) action under Regulation (EU) [748/2012](#), Part 21.A.3B.

### Recommendation(s):

In order to mitigate any safety risk related to the improper execution of rigging procedures and its subsequent inspection, EASA recommends taking the following proactive measures:

#### Familiarisation With Specific Sailplane Type

The necessary familiarisation with a new type of sailplane should not be limited to 'how to fly it' but should also include the rigging/derigging of the sailplane. Even if the flight manual offers detailed instructions how to perform the rigging, the familiarisation should be provided by a person familiar with the type of sailplane. This applies in particular to older (vintage) types of sailplanes, where the rigging procedures are not described in detail in the flight manual.

*It is recommended that familiarisation with the rigging procedure is provided by a person familiar with the type and in accordance with the approved instructions. This should include repetitive training of some rigging actions.*

#### Avoiding of Interruption and Distraction

Rigging errors, and other errors and omissions in preparing a glider for flight, are frequently caused by interruption, distraction, forgetfulness, and making unwarranted assumptions. EASA stresses the importance of rigging, and performing daily inspections and pre-flight checks, without interruption or distraction.

- Bystanders shall not interrupt people, who are rigging, carrying out daily inspections, or conducting their pre-flight checks.
- Persons, who are engaged in these activities should be assertive and ask not to be disturbed.
- Gliding sites should develop a culture that ensures global awareness of the importance of conscientious rigging, daily inspections, and pre-flight checks.
- It is beneficial to perform dual inspection of control connections, before inspection/assembly holes are closed.
- If rigging is conducted by a team, it should be ensured that one single person is responsible for directing operations of the rigging, and that the loose article (foreign objects) and positive control checks are undertaken.

#### Positive Control Checks

The vast majority of Aircraft Flight Manuals (AFM) require the execution of a positive controls check as part of the rigging procedure and the daily inspection. Most of the AFMs, however, do not indicate how to execute positive control checks.

Even if the AFM does not require positive control checks, it is strongly recommended to perform positive control checks as part of the daily inspection, regardless of whether the sailplane was just rigged or not, or it has automatic control connections.

The positive control check must involve at least two individuals: one to hold the control surface stationary, while the other attempts to move the flight control in both directions. It is

---

For information only. Recommendations are not mandatory



recommended that the person more familiar with the type performs the check at all the individual control surfaces.

Check steps:

1. The person at the control surfaces commands the person at the cockpit to move the controls into full deflection position and hold it.
2. The person at the control surfaces, gently pushes into the opposite direction, checking for resistance (an indication of correctly connected controls).
3. The above steps should be repeated for both deflections and in the neutral position of the control surfaces to check for play.

Note that a positive control check on its own may not be sufficient. It is imperative that the correct attachment is ensured by a good visual inspection (where possible) also.

In addition, it should be confirmed that the movement direction of the control surface corresponds with the control input and the full deflection angle is observed. This procedure should be applied for each control surface, including air brakes and flaps.

The procedure should also include a check of the airspeed indication (with necessary caution to avoid damages of the airspeed indicator). This can be done by gentle pushes on the opening of the pitot-tube.

Inspection following rigging, as well as daily inspections, should include the wing, wing tips, winglets and tailplane fittings, locking pins, pressure probe, rigging hatches. Check should be accomplished either by applying a positive force and/or proper positioning and securing. A functional check of the tow hook release(s) should also be carried out.

### **Use of Dedicated Checklists**

It is recommended that dedicated checklist (with illustrations, as applicable) is used during rigging and subsequent inspection.

### **Execution of Positive Control Check and Rigging Inspections**

It is recommended that the positive control checking and rigging inspections are performed by a qualified person, who was not involved in the rigging, or at least had a break between rigging and the positive control checking.

### **Sign-off of Daily and Rigging Inspections**

It is recommended that rigging and daily inspection get signed off by the responsible person that carries out that inspection. The sign-off can be done in the sailplane journey log or dedicated checklists could be used. An appropriate sign-off procedure established by the sailplane owner or operator could have significant positive *human factors* effect ("I should really check before I sign it off"). In the framework of their responsibility for flight safety, national gliding associations and their members should define a sign-off procedure in their regulations and enforce it as far as possible.

---

For information only. Recommendations are not mandatory



## Safety Promotion

It is recommended that gliding communities develop training material and sessions on rigging procedures and typical mistakes observed. The material and training should provide a basic understanding of the design, proper operation and the method of ensuring correct security of standard connections. Furthermore, that materials should explicitly highlight the importance of human factors and safety awareness as mentioned in this SIB, like under “Reasons for rigging errors” and “Avoiding of Interruption and Distraction”.

Safety awareness and a sense of responsibility need to be reinforced; each person involved in the rigging process has a responsibility and should be constantly aware of their contribution to safety. It is emphasised that the rigging and derigging of sailplanes is covered in the syllabus for the training of students. A student should be capable of rigging and derigging a sailplane before the pilot licence is issued.

### Avoidance of Common Connecting Errors:

- **Engage and Secure**

To engage means e.g., that a bolt is inserted into a bushing. In this condition, the connection can transmit forces, but the bolt can move out of the bushing again, therefore the connection is not secure. All connections need to be engaged and secured.

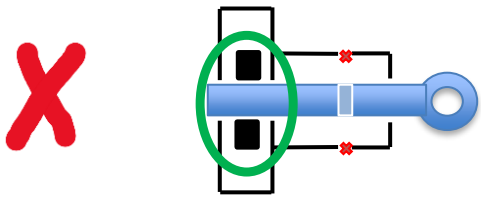
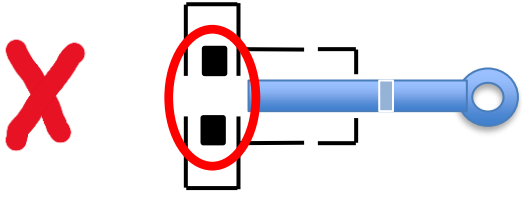
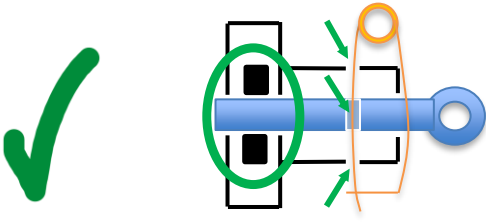
	
Engaged but <u>not</u> secured.	The bolt moved away from its engaged position, and the control is unconnected.
	The Fokker-needle needs to be pushed through both holes of the cage and the hole of the bolt.
Engaged and secured.	

For information only. Recommendations are not mandatory



An agency of the European Union



## Example of engage and secure of a main pin (wing connection)

PIK 20

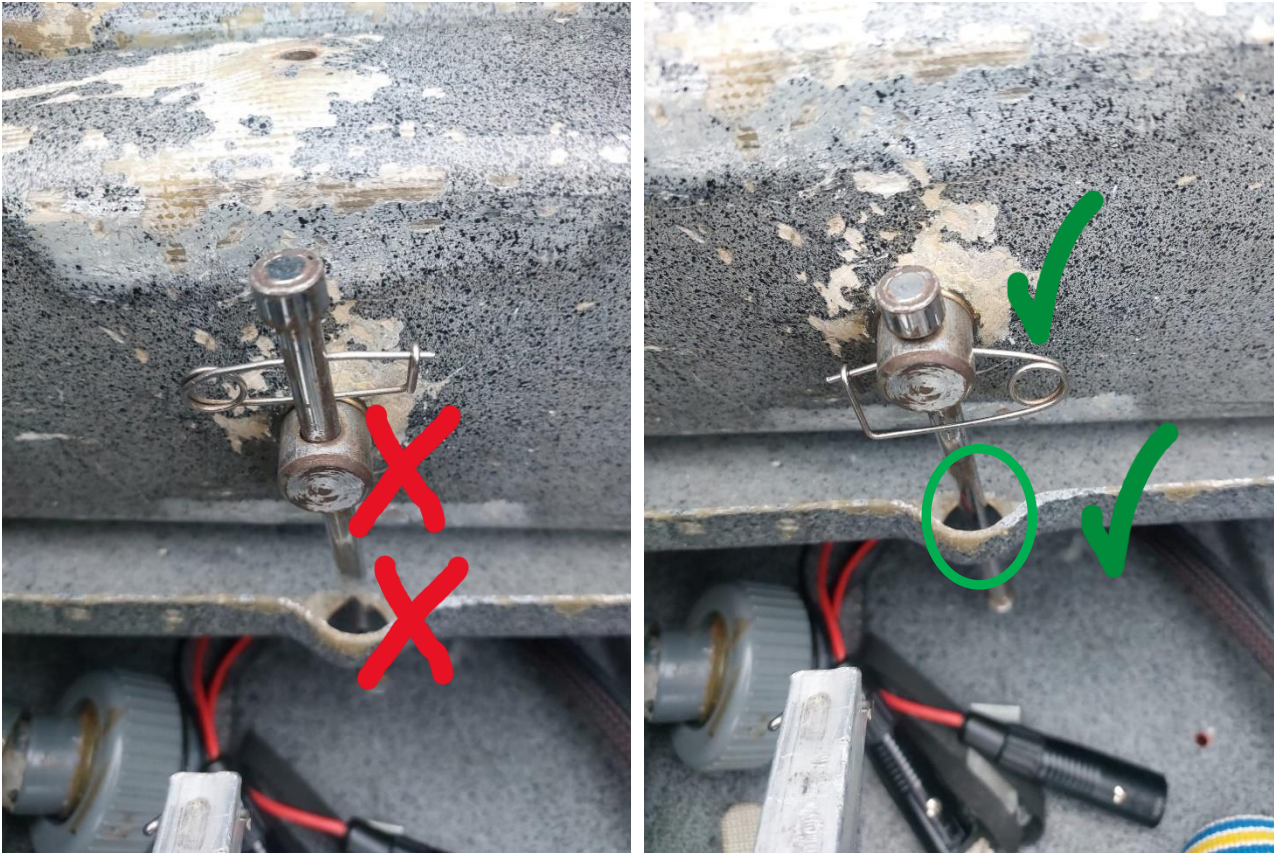

- **Securing of Castellated Nuts**

Some connections need to be secured against rotation. In most of the cases, this is achieved using a castellated nut and a Fokker-needle. The pin of the needle must be pushed through two castells and a hole inside the screw.

- **Manual Connections of Controls and Attachment of Horizontal Stabilizer**

Sailplanes requiring manual connection of controls are noticeable in accident statistics due to controls left not connected. Pilots may forget to connect the manual connections of controls after the attachment of the wings (successful rigging of wings favours relaxation – “job done” feeling). Similar scenarios may happen with horizontal stabilizers that have to be secured by a bolt, especially in cases where the application requires the use of a tool. The pilot attaches the horizontal stabilizer and walks away to collect the bolt and/or the respective tool. However, he/she may not return to finish the rigging and secure the horizontal stabilizer. Interruption and distraction are often contributing to these events.

For information only. Recommendations are not mandatory



An agency of the European Union

Alexander Schleicher models

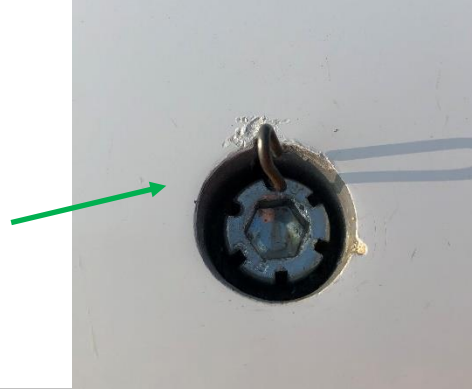

Installation of ASW 19 and later horizontal stabilizer. Screw need to be engaged and secured.

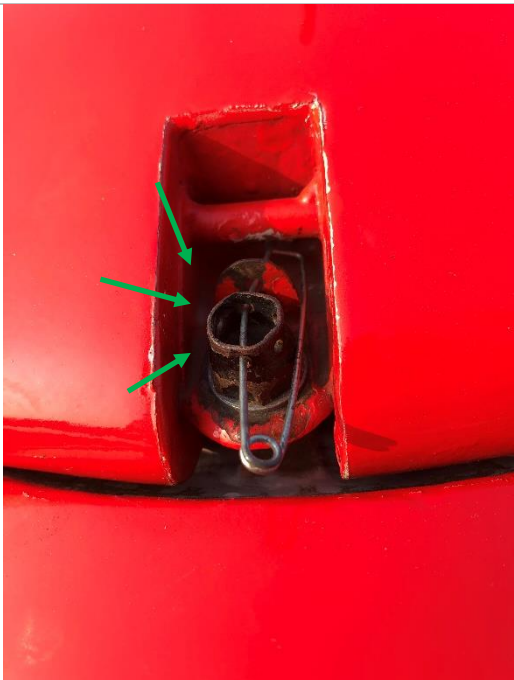





The bolt needs to be engaged and secured against rotation.

Installation of AS K-types horizontal stabilizer. The screw needs to be engaged and secured.

For information only. Recommendations are not mandatory



An agency of the European Union

Schempp-Hirth models		
		<p>Horizontal stabilizer engaged in its aft fitting but forward fitting not engaged.</p>
		<p>Horizontal stabilizer properly engaged.</p>
	<p>Locking lever in the wrong – unlocked – position (<i>on the wrong side</i> of the Safety Pin).</p> <p>In consequence, the locking hooks (left and right) are not engaged and the horizontal tailplane remains disconnected.</p>	

For information only. Recommendations are not mandatory





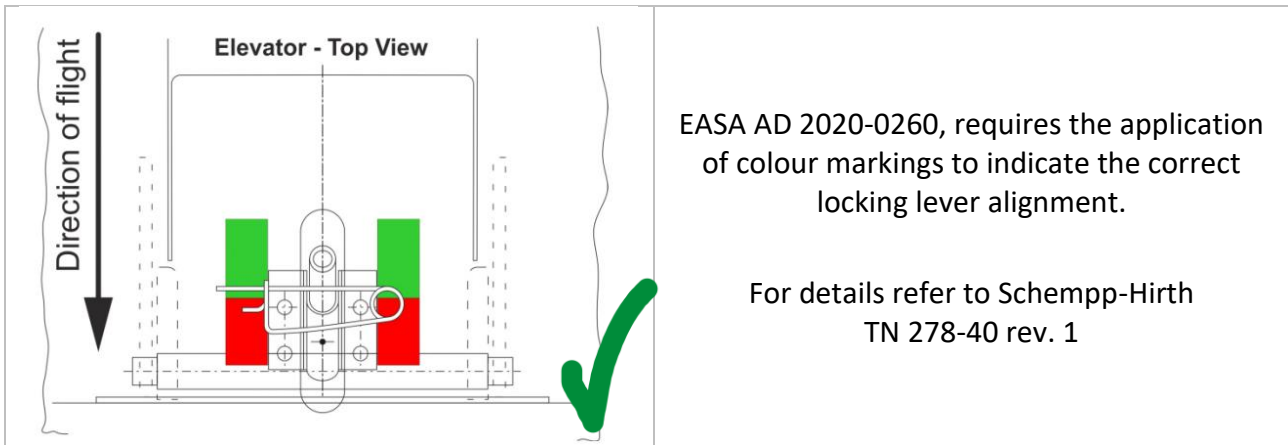

Ref.: AAIB-UK, [Bulletin 6/2020](#)

*Not all cases of unconnected controls and unconnected horizontal stabilizers can be detected by performing a positive control check. Non-interruption during the rigging procedure helps to prevent forgetting the connections in the first place. The checking of proper securing can be done by a visual inspection only.*

- **Securing of Manual Connections of Controls**

The example below shows an aileron connection, which is typical for old sailplanes with manual control connections. In this case, the connection was engaged during rigging, but not correctly secured. After three flights of short duration, the bolt moved away from its engaged position.

Ref: (BFU) Investigation Report [BFU18-1190-3X](#)



The connection was not secured. The Fokker-needle was put through one hole of the cage only, but not through the bolt and the lower hole of the cage, as well. In consequence, the bolt could move freely, and the control connection could become unconnected.



For information only. Recommendations are not mandatory

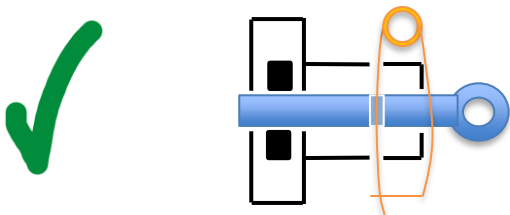
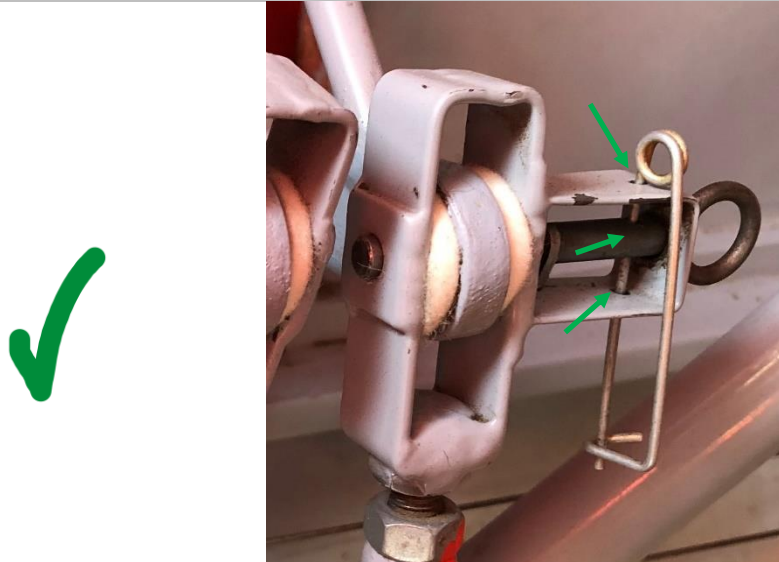

An agency of the European Union

	<p>The bolt is secured by pushing the Fokker-needle through <u>all three</u> holes.</p>
	<p>A straight and not bent needle supports its proper application.</p>

SZD / Allstar PZL Glider models – elevator and ailerons connections

For information only. Recommendations are not mandatory



*Connections, which are not properly secured, cannot be detected by positive control checks. The proper securing can be verified only by a manual inspection through turning, pulling, or shaking of the bolt and further visual inspection.*

- **Automatic Connections of Controls**

The typical automatic connection for the air brakes, ailerons, and flaps are located in the wing-to-fuselage joint. Those consist of a drive funnel inside the fuselage and a bell crank at the root rib of the wing. During assembly of the wing, it has to be ensured that the bell crank moves inside the drive funnel. Controls and control surfaces need to be in the positions as indicated by the flight manual, to ensure that the bell crank and drive funnels have the correct position to enable their proper connection.

Similar designs can be found for the control connection of the elevator. Pictures below show examples of a mis-rigged vertical stabilizer, which led to a fatal accident. The mis-rigging had its root cause in an unauthorized and apparently unrecorded modification, to make rigging easier.

SZD / Allstar PZL Glider SZD-55-1



Disconnected elevator control



Disconnected elevator control

Ref: AAIB UK - Aircraft Accident Report EW/C2017/04/01, [Bulletin 3/2018](#)

For information only. Recommendations are not mandatory



An agency of the European Union

TE.CAP.00117-008 © European Union Aviation Safety Agency. All rights reserved. ISO9001 Certified.  
Proprietary document. Copies are not controlled. Confirm revision status through the EASA-Internet/Intranet.

Page 11 of 16

DG Aviation models

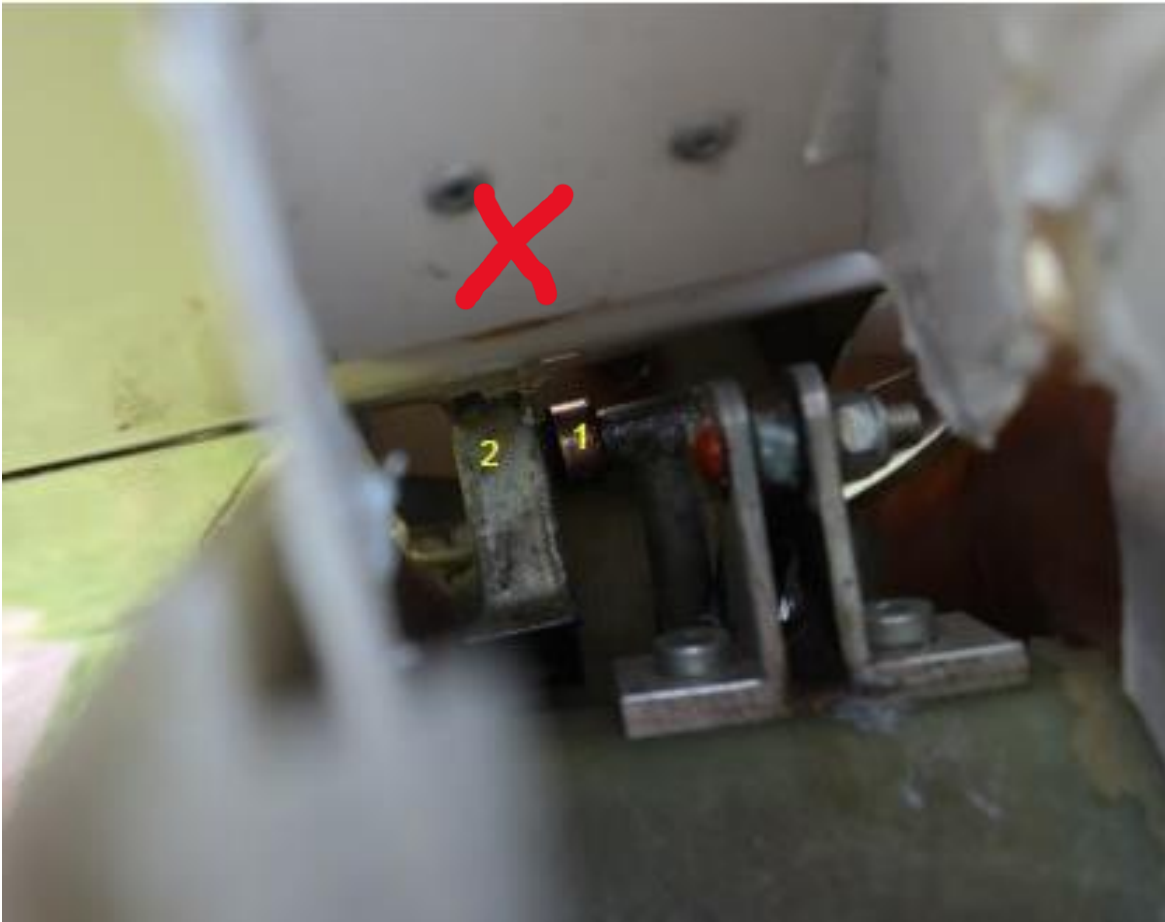





The roller at the fuselage side pushrod (1) is not inserted into the funnel (2) at the elevator

---

For information only. Recommendations are not mandatory





	<p>Check for correct elevator connection by looking through the Plexiglas window at the upper surface of the stabilizer: Elevator control connection is not performed correctly, if the roller is visible.</p>
	<p>Elevator control connection correct.</p> <p>For details refer to DG Aviation, Service Info No. 111/23</p>
	<p>The roller has to move into this funnel.</p>
	<p>Movement impaired by misplaced bracket. Roller most likely not in correct position.</p>

Ref: BEA Final Report [BEA2022-0176](#)

For information only. Recommendations are not mandatory



An agency of the European Union

TE.CAP.00117-008 © European Union Aviation Safety Agency. All rights reserved. ISO9001 Certified.  
Proprietary document. Copies are not controlled. Confirm revision status through the EASA-Internet/Intranet.

Page 13 of 16



*Those examples of rigging errors can usually be detected by a proper positive control check as indicated above.*

- **L'Hotellier Ball and Swivel Joint Quick Connectors**

A number of rigging accidents have involved the L'Hotellier quick connectors found in many popular sailplanes. While in many cases the connections had simply been forgotten, in others the pilot had made the connections incorrectly.

L'Hotellier connections rely upon proper engagement of a ball and socket, which are secured by a spring-loaded tab that must be pressed out of the way to make the connection. With the tab in position, a witness hole is exposed, allowing a locking pin/clip to be fitted to secure the connection. The controls can become disconnected in flight or during ground transport, if the pin is not fitted.

Unfortunately, the tab adopts a similar position when the ball and socket are completely disconnected and, although the ball is then locked out of the socket, it may in some cases engage sufficiently for the controls to seem connected. Being able to insert the locking pin does not guarantee that the connection has been properly made. The elevator can move during the pre-flight check, being pushed up by the control rod and moving down by gravity, even if the rod is completely disconnected. This can be detected and corrected by a positive control check.

It is crucial to check that the ball and socket are correctly engaged. This can be difficult, if access is tight or illumination poor; a torch and mirror, or telephone camera, can help.

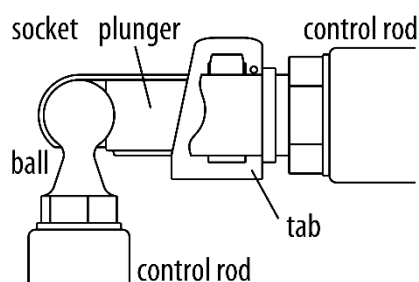

(a) Correct: cut-away shows how tab holds plunger in place

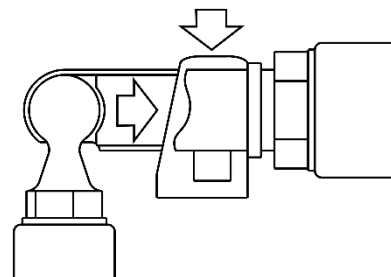

(b) Open: with tab depressed, plunger allows ball to be inserted or removed

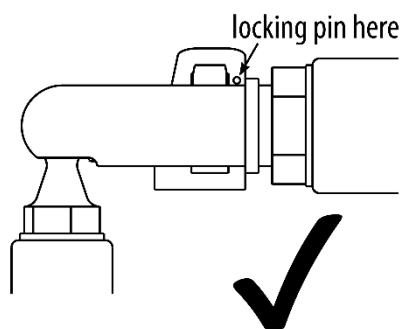

(c) Correct: ball engaged, locking pin may be inserted

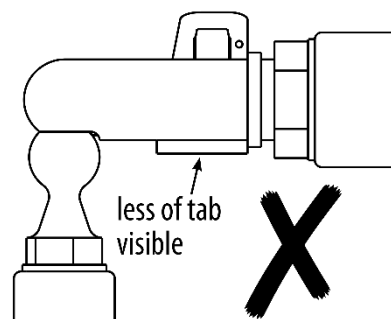



(d) Incorrect: ball not engaged, but locking pin may still be inserted

For information only. Recommendations are not mandatory

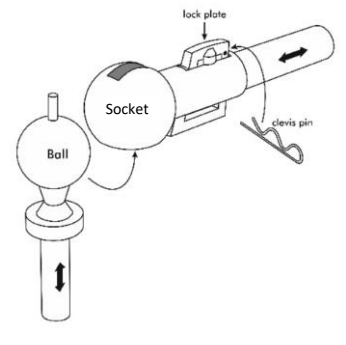

There are several common modifications to dispense with the locking pin.

	<p>The Wedekind locking sleeve slides outside the l'Hotellier fitting to secure the tab but does not necessarily prevent partial engagement.</p>
	<p>The Uerlings sleeve and similar threaded sleeve used on LS-sailplanes rotate or unscrew over the coupling and cannot be moved into position, if the ball and socket are only partially engaged.</p>
	<p>Newer l'Hotellier connectors come with a pin on the top of the ball that becomes visible outside the socket, once the ball and socket are properly engaged. The pin allows also for a tactile inspection. The connection still needs to be secured.</p> <p>However, the pin on the top can cause the controls to move during the pre-takeoff check, falsely confirming a proper connection, even if the ball is not fully inserted and the socket is only resting on the ball with the pin.</p>

Remark: The maintenance instructions of l'Hotellier, in particular about ball wear need to be respected.

*To check the proper engagement of l'Hotellier connectors, a positive control check is strongly recommended.*

Ref: AAIB UK, Aircraft Accident Report [AAIB-28680](#)

Ref: DSB, [Quarterly Aviation Report 2023-4](#)

- **Expanding main pins of main wing connection**

The wing rigging pins for most gliders are smooth cylinders, but those for e.g. the SZD-12/22 Mucha 100/Std., SZD-24/32 Foka 4/C/5, SZD-36 Cobra, SZD-8 Jaskółka, SZD-9bis Bocian 1E, Schempp-Hirth SHK and Schempp-Hirth Austria, consist of expanding pins/cones, which must be fitted exactly in accordance with the instructions of the flight manual. If the pin/cone is not correctly located, the wings can fold up and detach from the fuselage. Unless inspection holes have been cut for the purpose, it can be very difficult in some gliders to see whether the fitting has been assembled correctly.

For information only. Recommendations are not mandatory



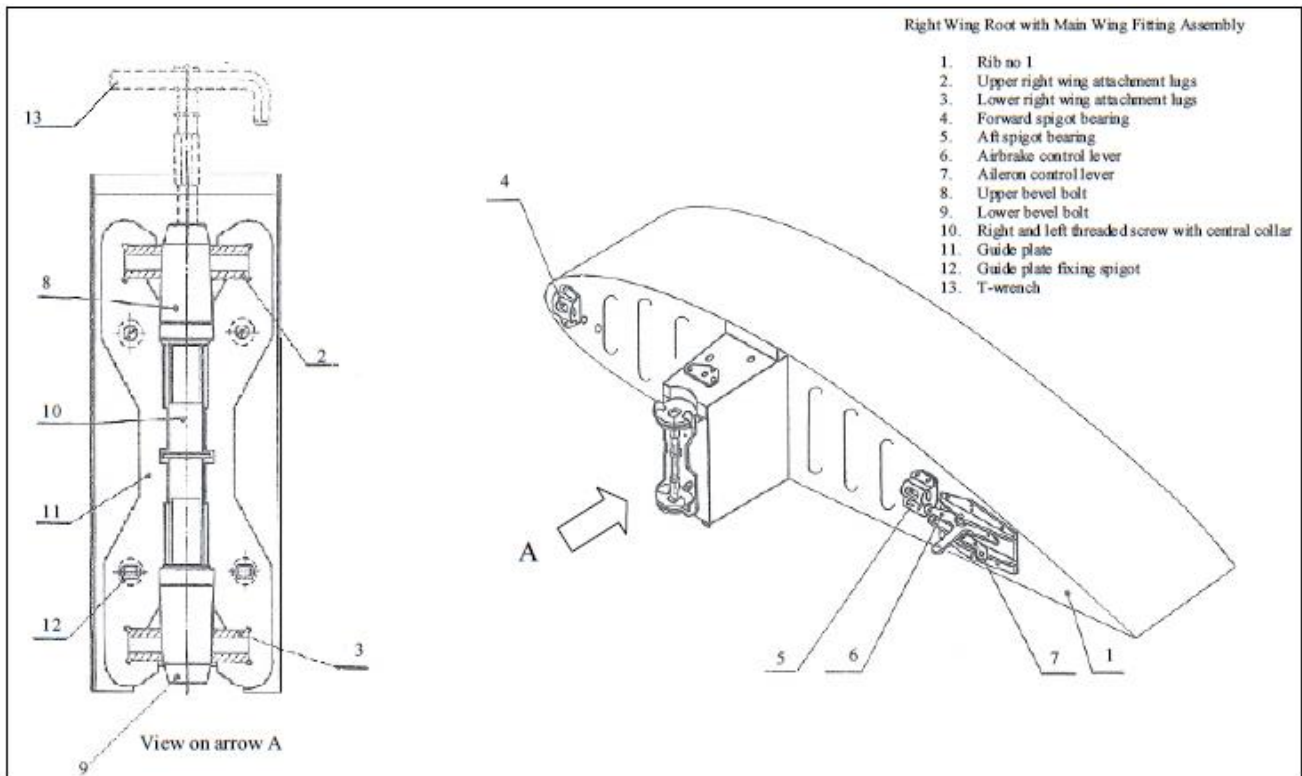

Example of an expanding main pin wing connection.

Ref: AAIB UK - Aircraft Accident Report [EW/C2010/08/02](#)

*In case of sailplanes with expanding main pin wing connections, practice rigging should be carried out under the supervision of someone who is familiar with the sailplane type.*

- **Retrofit of automatic control connections**

In case automatic control connections are available as retrofit to a specific sailplane, it is strongly recommended to embody such modification. The risk of not connected or wrongly connected controls is significantly reduced by automatic control connections. The same is valid for improved attachments.

**Contact(s):**

For further information contact the EASA Safety Information Section, Certification Directorate.

E-mail: [ads@easa.europa.eu](mailto:ads@easa.europa.eu)

For information only. Recommendations are not mandatory



An agency of the European Union